



**Alumínios e Acessórios, Lda**

# SÉRIE DE CORRER THERMOLINE

**SEDE:**

AV<sup>a</sup> DE LISBOA, 41

2605-801 CASAL DE CAMBRA

Tel: 219 809 710 Telm: 912 556 035 Fax: 219 809 719

E-mail: [geral@alumace.pt](mailto:geral@alumace.pt) / [encomendas@alumace.pt](mailto:encomendas@alumace.pt)

**FILIAL:**

RUA ANTÓNIO PEDRO MENDONÇA, 54 A







PINHAL DE FRADES

2480-162 SEIXAL

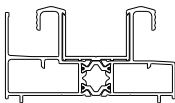
Tel: 212 258 544 Telm: 918 554 022 Fax.: 212 240 293

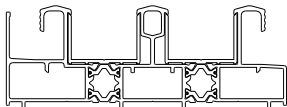
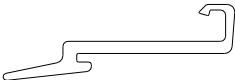
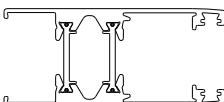
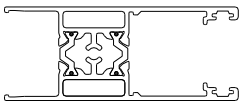
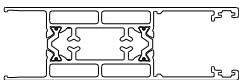
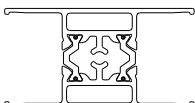
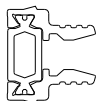
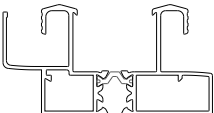
E-mail: [filial@alumace.pt](mailto:filial@alumace.pt)

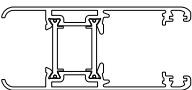
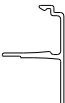
[www.alumace.pt](http://www.alumace.pt)

Perfil	Referência	Pg.	Perfil	Referência	Pg.
	TL0001	3		PVC207	3
	TL0003	3		PVC255	3
	TL0005	2			
	TL0006	2			
	TL0007	2			
	TL0008	2			
	TL0009	3			
	TL0011	3			
	TL0015	2			
	TL0035	2			
	P09007	3			
	P09009	3			

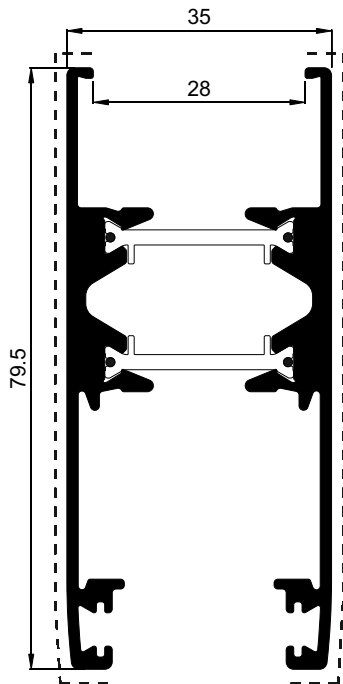

TL0005

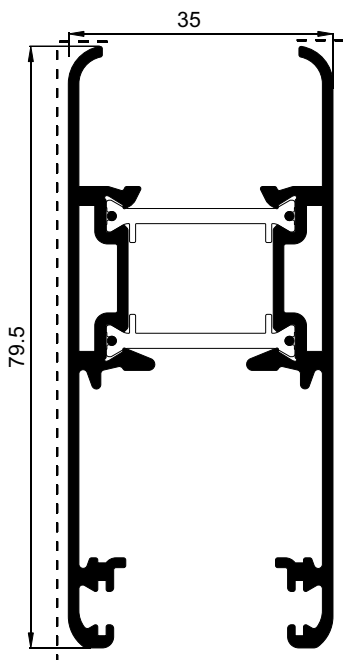

TL0035

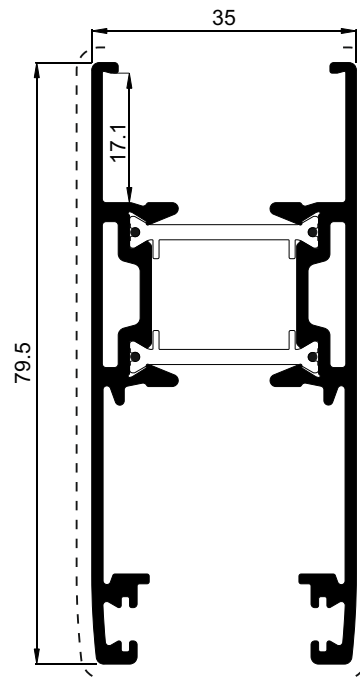

TL0015

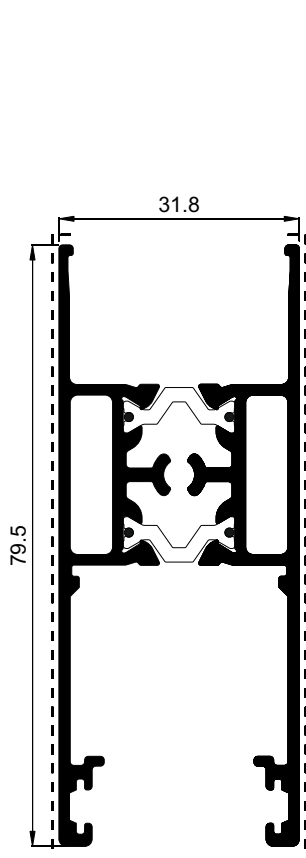

TL0006

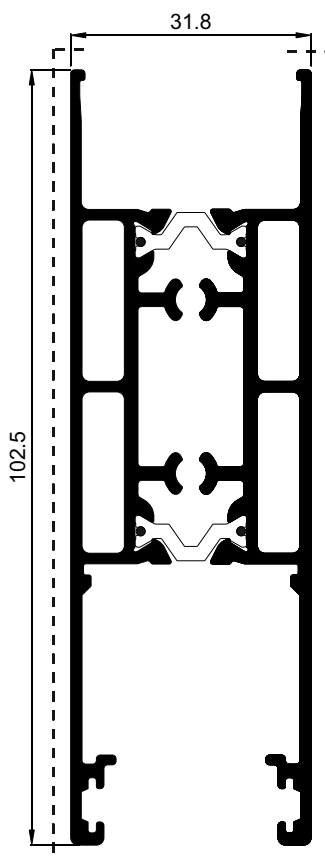

TL0007

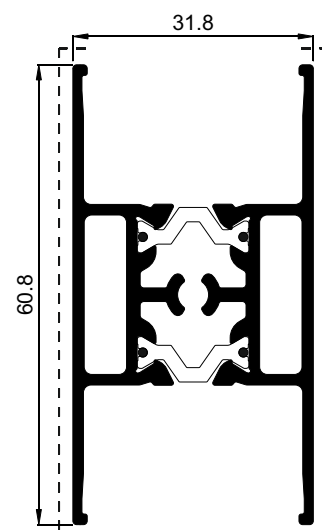

TL0008

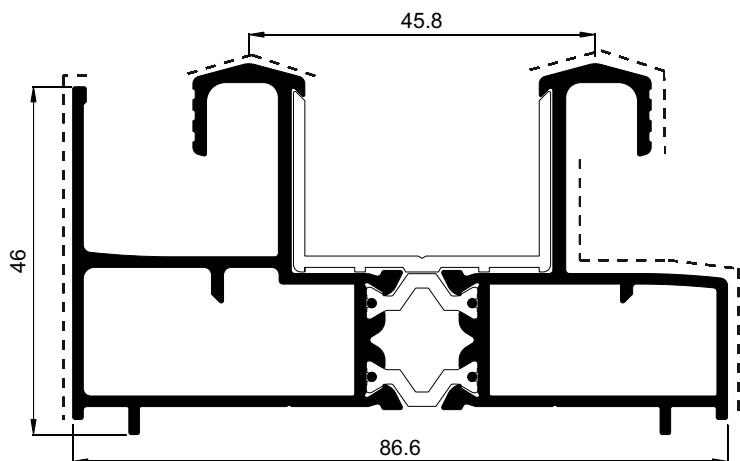

**TL0001**

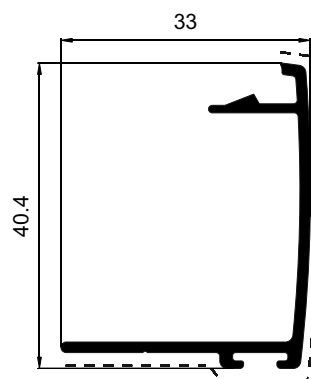

**P09009**

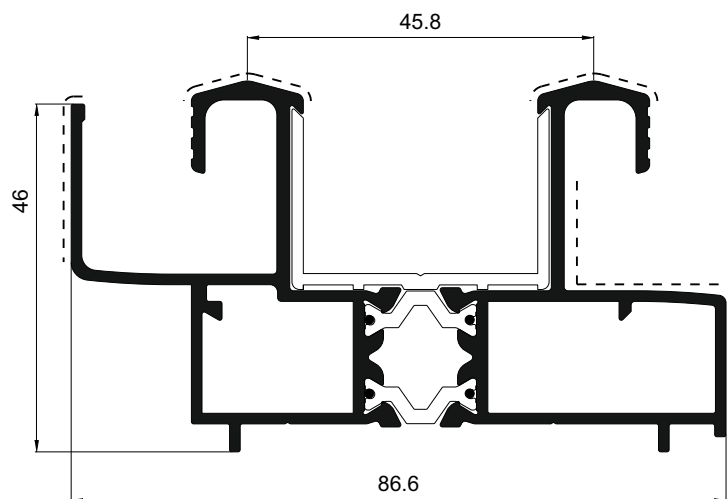

**TL0011**

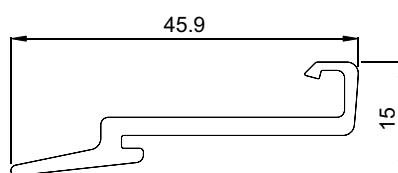

**PVC255**

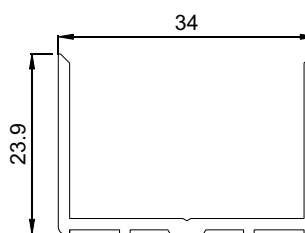

**PVC207**

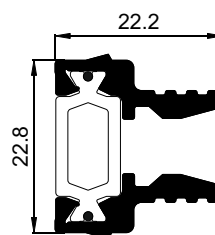

**TL0009**

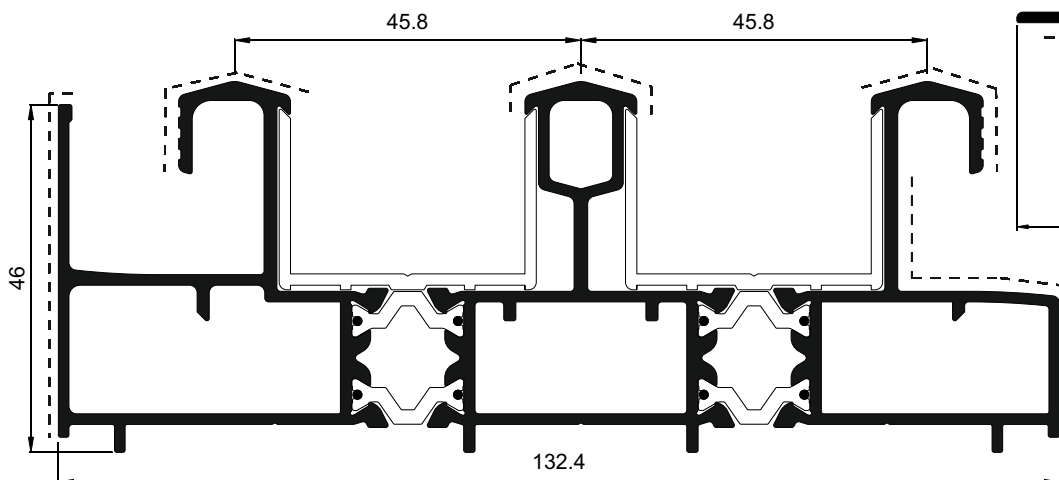

**TL0003**

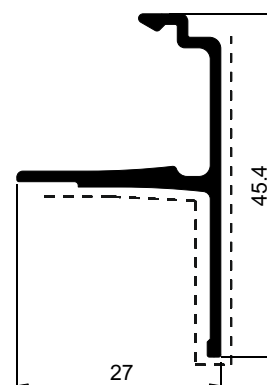

**P09007**