



**Alumínios e Acessórios, Lda**

# SÉRIE DE CORRER CONFORT

**SEDE:**

AV<sup>a</sup> DE LISBOA, 41

2605-801 CASAL DE CAMBRA

Tel: 219 809 710 Telm: 912 556 035 Fax: 219 809 719

E-mail: [geral@alumace.pt](mailto:geral@alumace.pt) / [encomendas@alumace.pt](mailto:encomendas@alumace.pt)

**FILIAL:**

RUA ANTÓNIO PEDRO MENDONÇA, 54 A







PINHAL DE FRADES

2480-162 SEIXAL

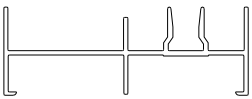
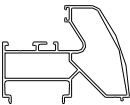
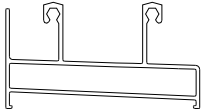
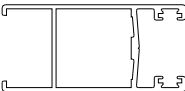
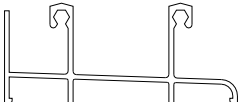
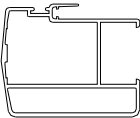
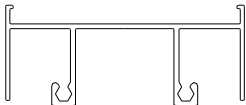
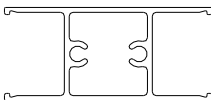
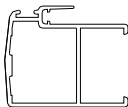
Tel: 212 258 544 Telm: 918 554 022 Fax.: 212 240 293

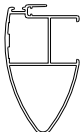
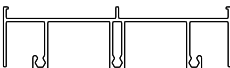
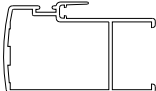
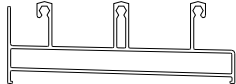
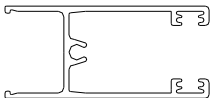
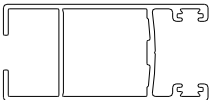
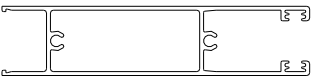
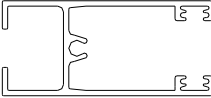
E-mail: [filial@alumace.pt](mailto:filial@alumace.pt)

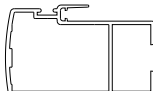
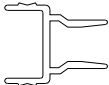
[www.alumace.pt](http://www.alumace.pt)

Perfil	Referência	Pg.	Perfil	Referência	Pg.
	P04167	3		P04377	3
	P04168	3		P04381	2
	P04169	3		P04509	2
	P04170	3		P04553	4
	P04171	2		P05250	5
	P04172	2		P05251	5
	P04173	2		P05252	5
	P04176	4		P05389	2
	P04177	4		P05391	2
	P04178	4		P05776	2
	P04179	3			
	P04182	3			

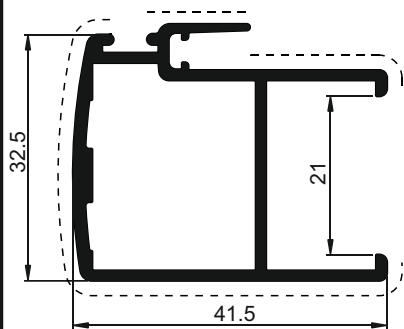

**P04171**

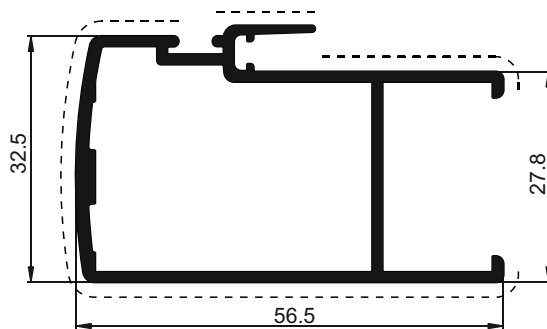

**P04173**

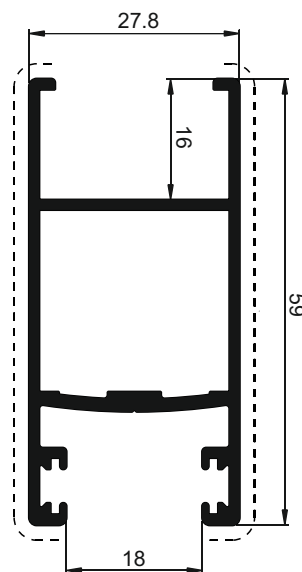

**P04381**

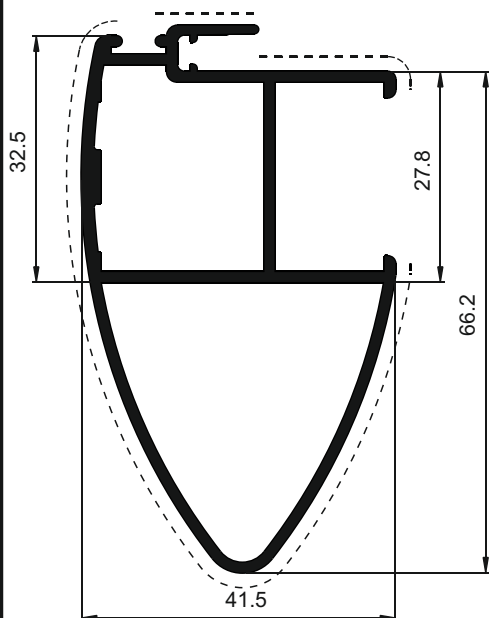

**P04172**

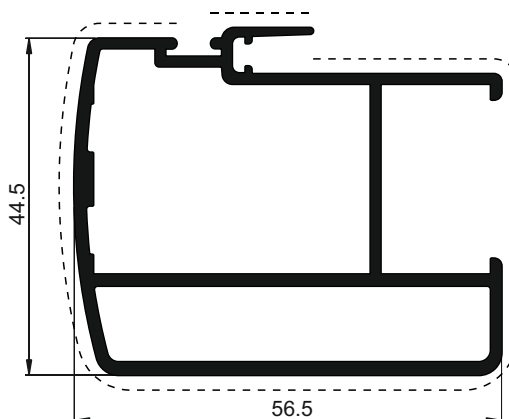

**P04509**

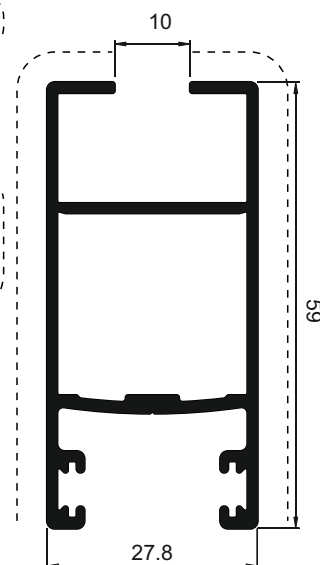

**P05389**

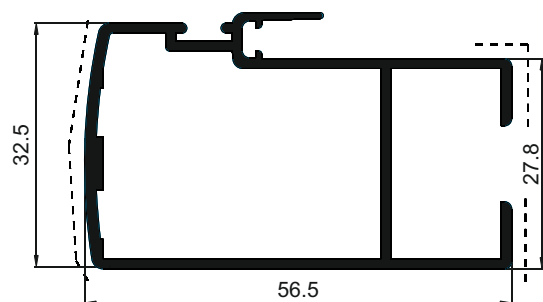

**P05776**

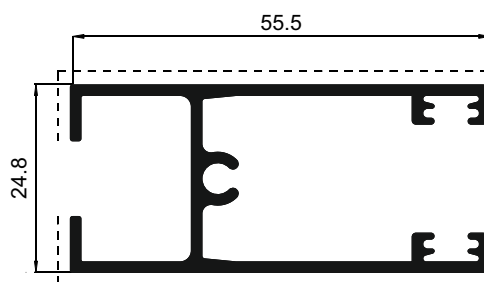

**P05391**

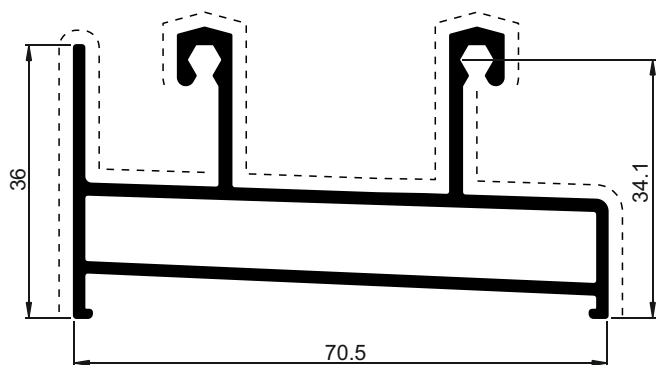

P04168

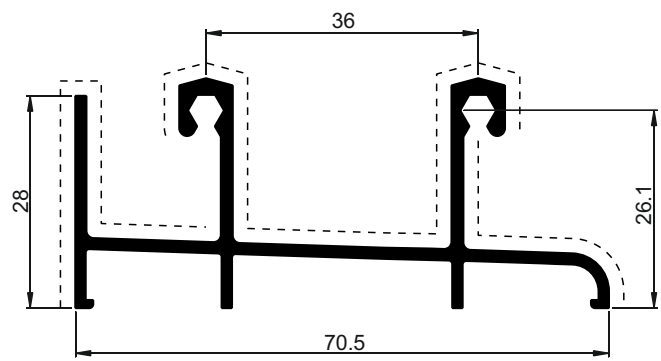

P04169

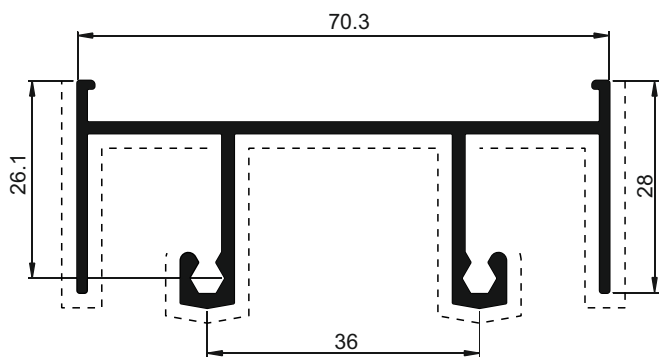

P04170

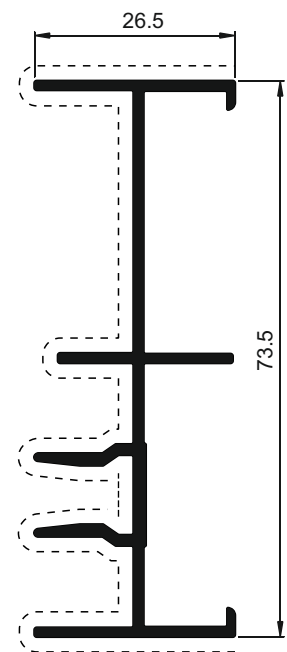

P04167

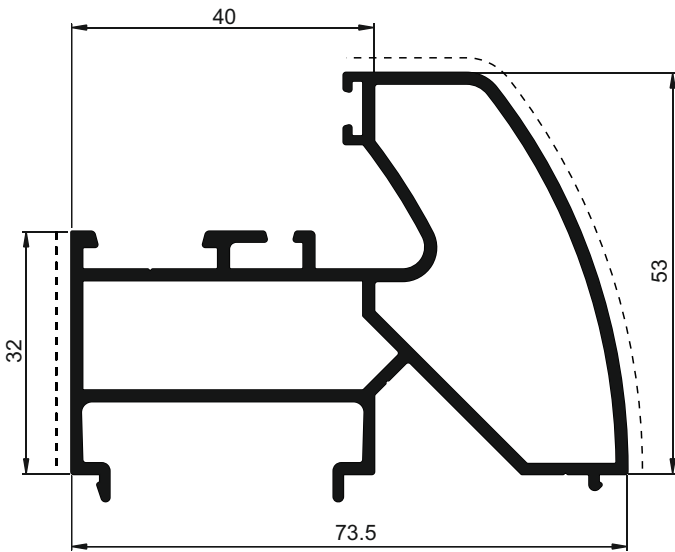

P04377

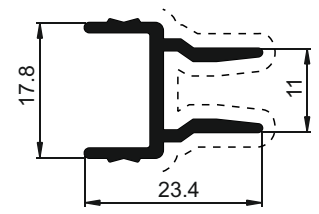

P04179

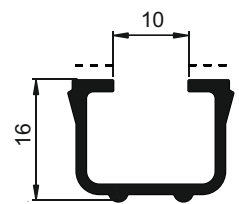

P04182

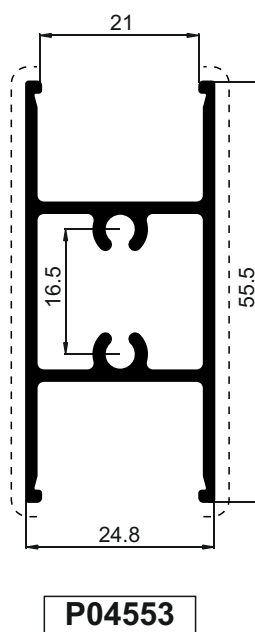
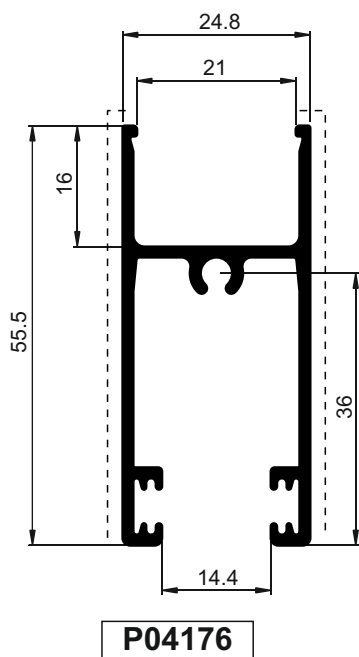
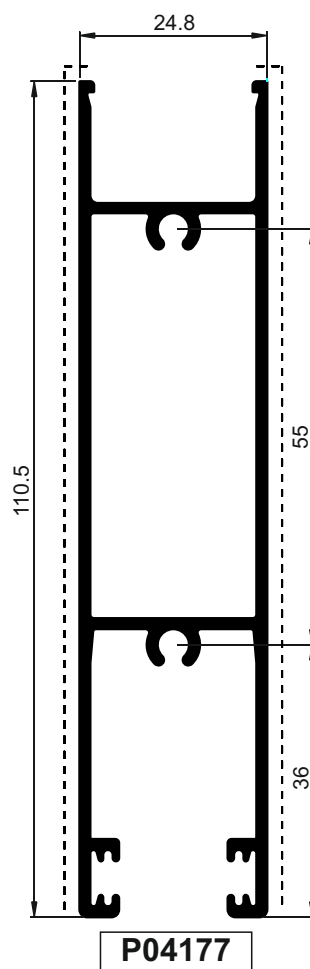
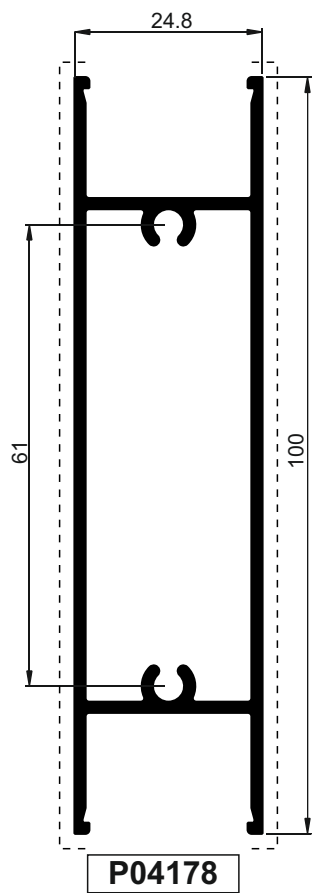

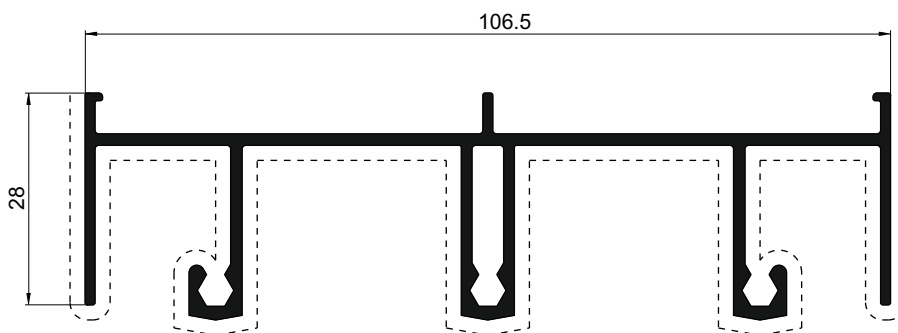

P05251

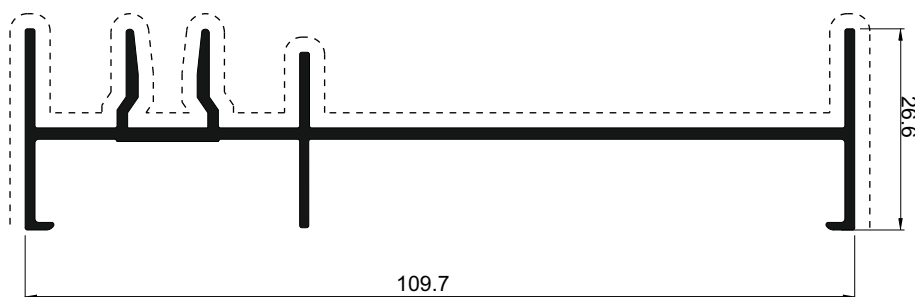

P05250

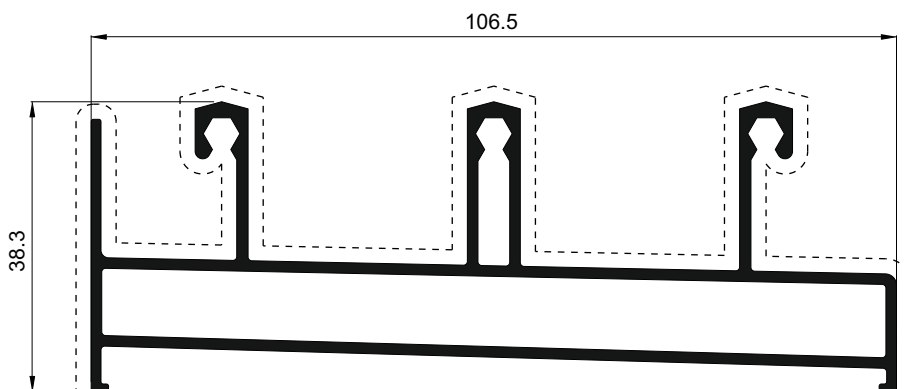

P05252